

Pablo®

BELMONT

BELMONT

DESCRIPTION

The Belmont Collection was a collaborative creation with designer Brad Ascalon re-envisioning the traditional fabric shade lamp but with the warmth and preciousness of hand crafted furniture. Belmont's iconic, yet reductive form creates a natural canvas for displaying an exquisite array of textiles from premium wool to colorful woven fabrics that can be paired with a solid crafted wood armature in oak. Belmont can be hung individually or in stunning groupings to provide warm and comfortable illumination to complement any residential, contract, or hospitality setting.

DESIGNER

Brad Ascalon 2017

MATERIALS

- Fabric Shade
- Solid Oak Details
- Fabric Cord
- PMMA Diffuser
- Steel Canopy

FEATURES

- Fully Dimmable
- Matching Wood Canopy Cover

SPECIFICATIONS

- Voltage: 110/240V 50-60Hz
- Power Consumption: 30W
- Color Temperature: 2700K
- Luminosity: 1200 Lumens
- Color Rendition Index: 95 CRI
- 50K hour lifespan
- Cable Length: 10' (3m) (Field cuttable)

MODELS

- Belmont 22
- Belmont 26



DIMENSIONS

BELMONT

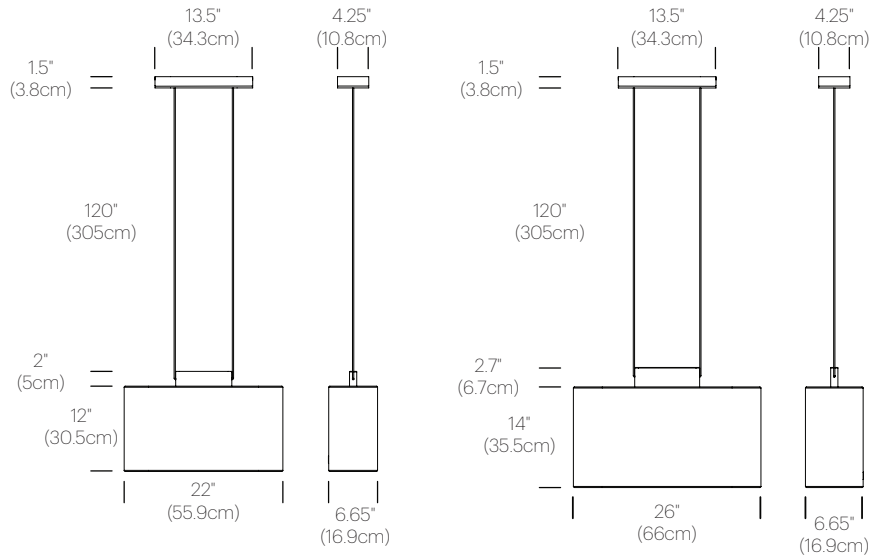

FINISH OPTIONS

BELMONT

FABRIC



Silverdale



Charcoal



Dijon



Celeste

WOOD



Oak

Pablo®

888 MARIN STREET SAN FRANCISCO, CA 94124
PABLODESIGNS.COM